

**PIMECCO**

Piping & Mechanical Construction Co. Ltd.



Borulama ■ Mekanik ■ İnşaat



# PIPING & MECHANICAL CONSTRUCTION

## **PİMECCO Mühendislik,**

Türkiye'nin en büyük sanayi merkezi Bursa da kurulan firmamız, sanayi tesislerinin ihtiyaçlarına yönelik proje, imalat ve montaj hizmeti veren endüstriyel bir taahhüt firmasıdır.

Mekanik tesisat alanında faaliyet gösteren firmamız üstlendiği işlerin dizaynını, uygulama projelerinin hazırlanmasını ve sahada uygulamasını yaparak sistemi bir bütün olarak çalışır vaziyette teslim etmektedir.

Kuruluşu üzerinden uzun bir süre geçmemesine rağmen çok hızlı bir büyüme gösteren firmamızın Çorlu/Tekirdağ'da yeni şubesi hizmete açılmıştır.

Kendi alanında uzman teknik kadrosu ve deneyimli ekiplerimizle sizlere en iyi hizmeti vermek için çalışmalarımıza devam etmekteyiz.

**Gelecek Hayalimiz:** Alanımızda Türkiye'nin en saygı duyulan kurumu olacağız.

**Değerlerimiz:** Dürüstlük, iş kalitesi, girişimcilik, yurt sevgisi ve hoşgörü.

Tüm attığımız adımları bu çekirdek değerlerle atıyoruz.

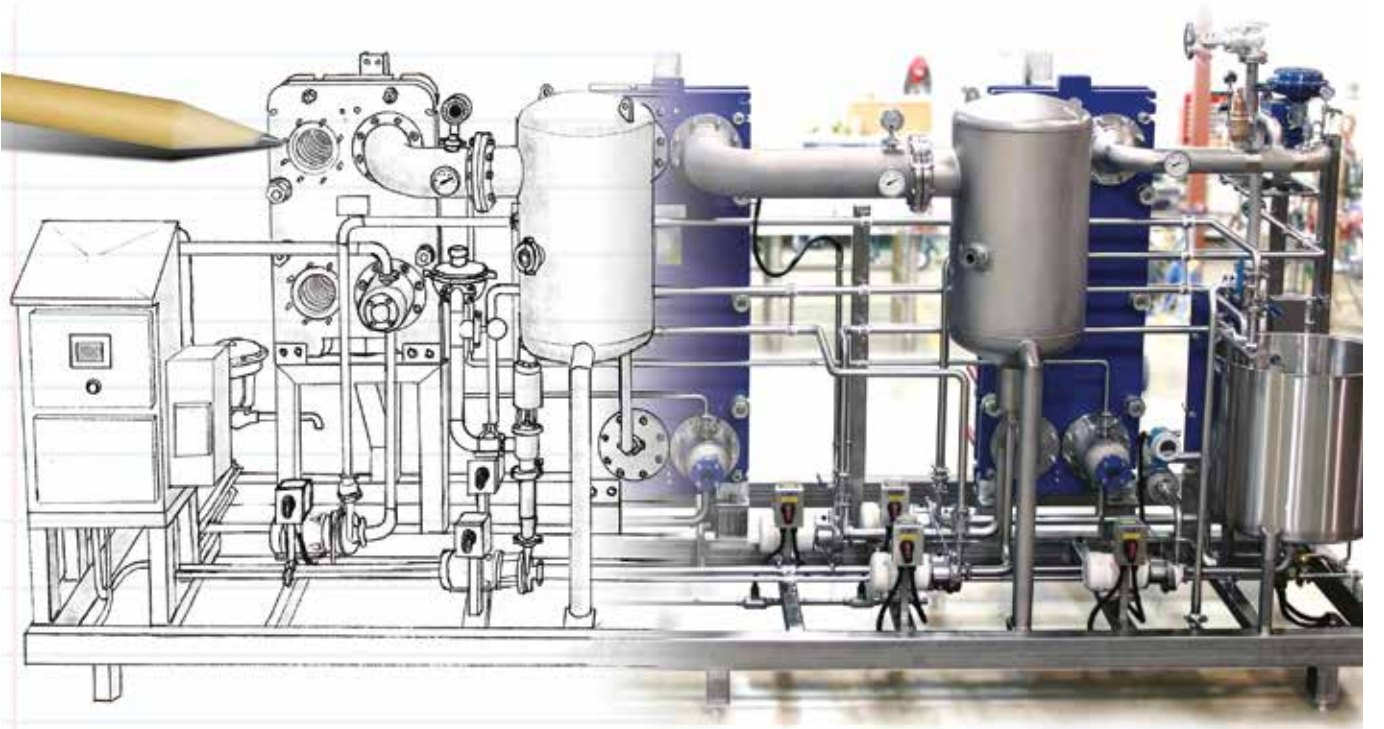



## FAALİYET ALANLARIMIZ

- Mekanik Tesisat ve Mühendisliği
- Endüstriyel Tesisat Borulama İşleri
- Gıda Sektörü Hijyenik Paslanmaz Kaynak İşleri
- Sanayi Makinaları ve Endüstriyel Ekipman Montajı
- Projelendirme ve Saha Yönetimi
- Nitelikli Personel Temini (Mühendis, Borucu, Kaynakçı vs.)
- Gaz hatları (Doğalgaz, Argon, Azot, Basınçlı hava)
- Tank imalatı ve Spool İmalatı
- Yangın Koruma Sistemleri
- Isıtma/Soğutma Sistemleri
- Sıhhi Tesisat ve Yağmur Suyu Tesisatı
- Endüstriyel Havalandırma İşleri
- Çelik Konstrüksiyon İmalat ve Montaj
- Isı Yalıtım ve İzolasyon
- Kazan Borusu Değişim İşleri



# ÇALIŞMA SAHALARIMIZ



- Enerji Santralleri
- Demir Çelik Fabrikaları
- Tekstil Fabrikaları
- Gıda Fabrikaları
- Otomotiv Fabrikaları
- Çimento Fabrikaları
- Kimya Tesisleri
- Petrol Rafinerileri
- Tersaneler
- Dökümhaneler
- İmalat Atölyeleri





# MÜHENDİSLİK HİZMETLERİMİZ

## 1. Eğitim Hizmetlerimiz

- a- Devreye alma eğitimleri (Buhar, kondens, basınçlı hava, yangın, soğutma suyu hatları, proses hatları)
- b- Buhar sistemi eğitimleri
- c- Bakım eğitimleri (Enstrüman bakım)

## 2. Danışmanlık Hizmetleri

- a- Sürekli danışmanlık
- b- Proje uygulama süreci danışmanlık hizmeti (Ücretsiz)
- c- Proje yönetimi planlama ve organizasyon

## 3. Proje Hizmetleri

- a- Fizibilite çalışması. Çalışma sahasının projeye uygunluk ön çalışması, P&ID ve PFD çizimleri
- b- 3D proje hizmetleri (Üç boyutlu fabrika - proses modellemeleri)
- c- Proses iyileştirme projeleri
- d- Boru stress analizleri
- e- Reaktor, eşanjör, mikser, basınçlı kap ve tank tasarımları, yerleşimi ve projelendirilmesi

## 4. Enerji Etüt Hizmetleri

- a- Buhar - Kondens
- b- Basınçlı hava hattı (Hava kaçak tespiti)
- c- Termal incelemeler (İzolasyon kayıpları, eksik-hatalı izolasyonlar)

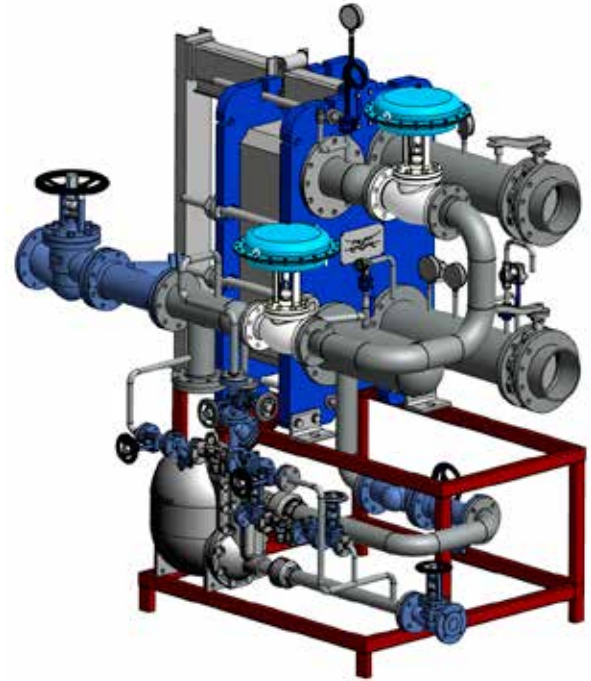

## PAKET SİSTEM ÇÖZÜMLERİMİZ

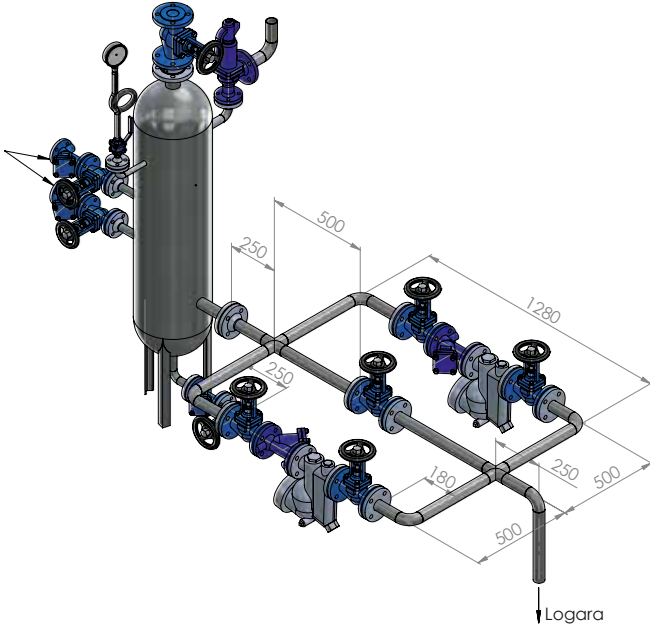

1. Flaş buhar geri kazanım sistemleri
  - a- Flaş buhar tankları
  - b- Atmosferik flaş buhar geri kazanım sistemi
  - c- Termokompresör sistemi
2. Yüzey blöf enerji geri kazanım sistemleri
3. Degazör flaş buhar geri kazanım sistemleri
4. Plakalı eşanjör paket sistem çözümleri
5. Tübüler (Borulu eşanjör) paket sistem çözümleri
6. Makine montaj, Ddemontaj hizmetleri (Mekanik tesisat dahil)

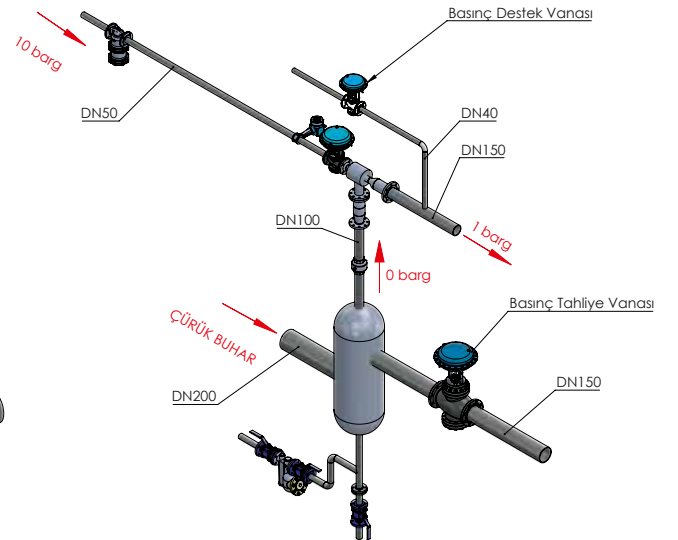
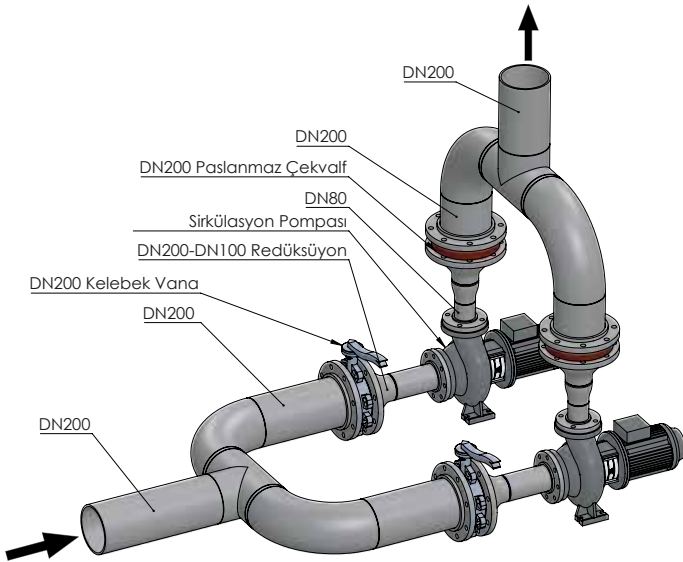



# ÇALIŞMA PRENSİBİMİZ



Pimecco Mühendislik 5M+Q+S formatında çalışmasını tamamlamaktadır.

- Yöneticilerimiz yapılacak iş ile ilgili gerekli metodu belirledikten sonra gerekli malzeme listesi ve işin yapımı için gerekli tüm ekipman teminini yaparak sahaya personelini sevk ederek işin başlamasını sağlar.
- İşin yapım aşamasında kalite ve iş güvenliğinden taviz vermeden işini bitirmeyi hedeflemektedir.



# ÇALIŞMALARIMIZDAN ÖRNEKLER

## ASİL ÇELİK SAN. ve TİC. A.Ş.

• 350 Bar Descaller su hattı imalat ve montajı







## NESTLE TÜRKİYE GIDA SAN. A.Ş

- HDPE Yağmur suyu imalat ve montajı
- Ceketli boru ve paslanmaz boru imalatı
- Ceketli tank imalat ve montajı



# ÇALIŞMALARIMIZDAN ÖRNEKLER

## SUR YAPI ENDÜSTRİ SAN. ve TİC. A.Ş.

- İstanbul Greenium vilları mekanik oda revizyon işleri





## PINAR SU SAN. ve TİC. A.Ş.

- Cam damacana yıkama hattı makine bağlantıları ve mekanik tesisat işleri



# ÇALIŞMALARIMIZDAN ÖRNEKLER

## ASİL ÇELİK SAN. ve TİC. A.Ş.

- 38 Burnerli tav fırınının komple doğalgaz tesisatı, azot hattı ve basınçlı hava hatlarını projelerine uygun, %100 filmlik kaynak vererek, sertifikalı kaynakçılarımızla, 1/2"den 14"e kadar olan boru çaplarında toplam 1700 mt. doğalgaz borusu 35 günde testler dahil teslim edilmiştir.





## ASİL ÇELİK SAN. ve TİC. A.Ş.

- Orta kesit haddehane revizyonu kocks media boru hatları ve diğer ilave işlere ait borulama, imalat, demontaj ve montajı.



# ÇALIŞMALARIMIZDAN ÖRNEKLER

## SAVOLA GIDA SAN. ve TİC. A.Ş.

- Yeni endüstriyel margarin üretim tesisinin tüm dış ürün hatlarının imalat ve montajı yapılarak teslim edilmiştir.





## BHS HAŞIL VE TEKSTİL ÜR. TİC. VE SAN. A.Ş.

- Fabrikanın tüm buhar, su, hava ana hatları ve makine bağlantıları yapılarak teslim edilmiştir.



# ÇALIŞMALARIMIZDAN ÖRNEKLER

## COŞKUNÖZ A.Ş.

- Süg4 fabrikası anahtar teslim tüm mekanik tesisat işler yapılmıştır.
- Fabrika mekanik tesisat bakım ve revizyonları yapılmıştır.
- Fabrika makinalarının mekanik tesisat bağlantıları yapılmıştır.







## ANADOLU HOLDİNG

- Balıkesir Gönen çiftliğinin arazi sulamada kullandıkları kollektörün imalat ve montajı işidir.



# ÇALIŞMALARIMIZDAN ÖRNEKLER

## BURSA EKMEK ve BESİN SAN. ve TİC. A.Ş.

- Enerji verimliliği kapsamında tüm buhar hatları gözden geçirilerek yeniden projelendirilip imalat ve montajı yapılmıştır.

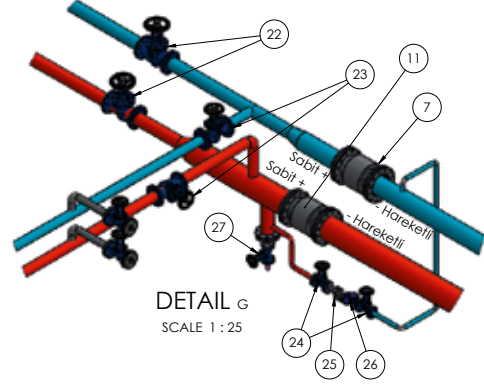
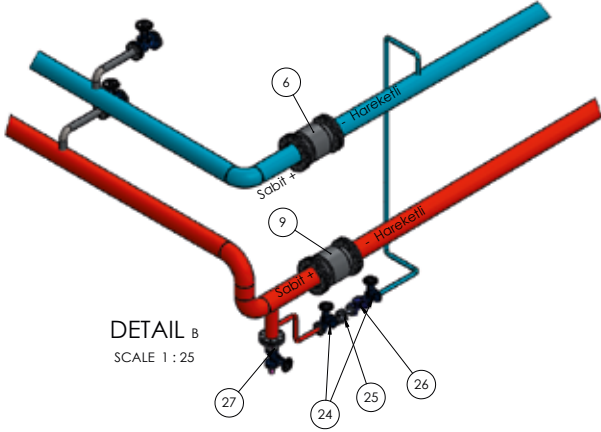



## GEMPORT GEMLİK LİMAN VE DEPOLAMA İŞL.A.Ş

• Fabrika yangın hatları bakım onarım hizmetleri



# ÇALIŞMALARIMIZDAN ÖRNEKLER

## ALTINSU TEKSTİL ENERJİ SAN. VE TİC. LTD. ŞTİ.

- Jet yıkama makinelerinin buhar ve su hatlarının imalat ve montajları yapılarak teslim edilmiştir.





## MKS MARMARA ENTEGRE KİMYA SAN. A.Ş.

- Formik asit üretim tesisi tüm mekanik tesisat işleri yapılarak teslim edilmiştir.



# ÇALIŞMALARIMIZDAN ÖRNEKLER

## AED ALÜMİNYUM ENJEKSİYON SAN. TİC. LTD. ŞTİ.

- Fabrikanın tüm doğalgaz tesisatının imalat ve montajı yapılarak teslim edilmiştir.





## AKSA AKRİLİK KİMYA SANAYİİ A.Ş.

- Kömür santrali kazan borusu numune alma işi, numune sonrası P11 flimlik kaynak yapılarak iş teslim edilmiştir.









## MKS MARMARA ENTEGRE KİMYA SANAYİ A.Ş.

• Kum silosu imalat ve montajı

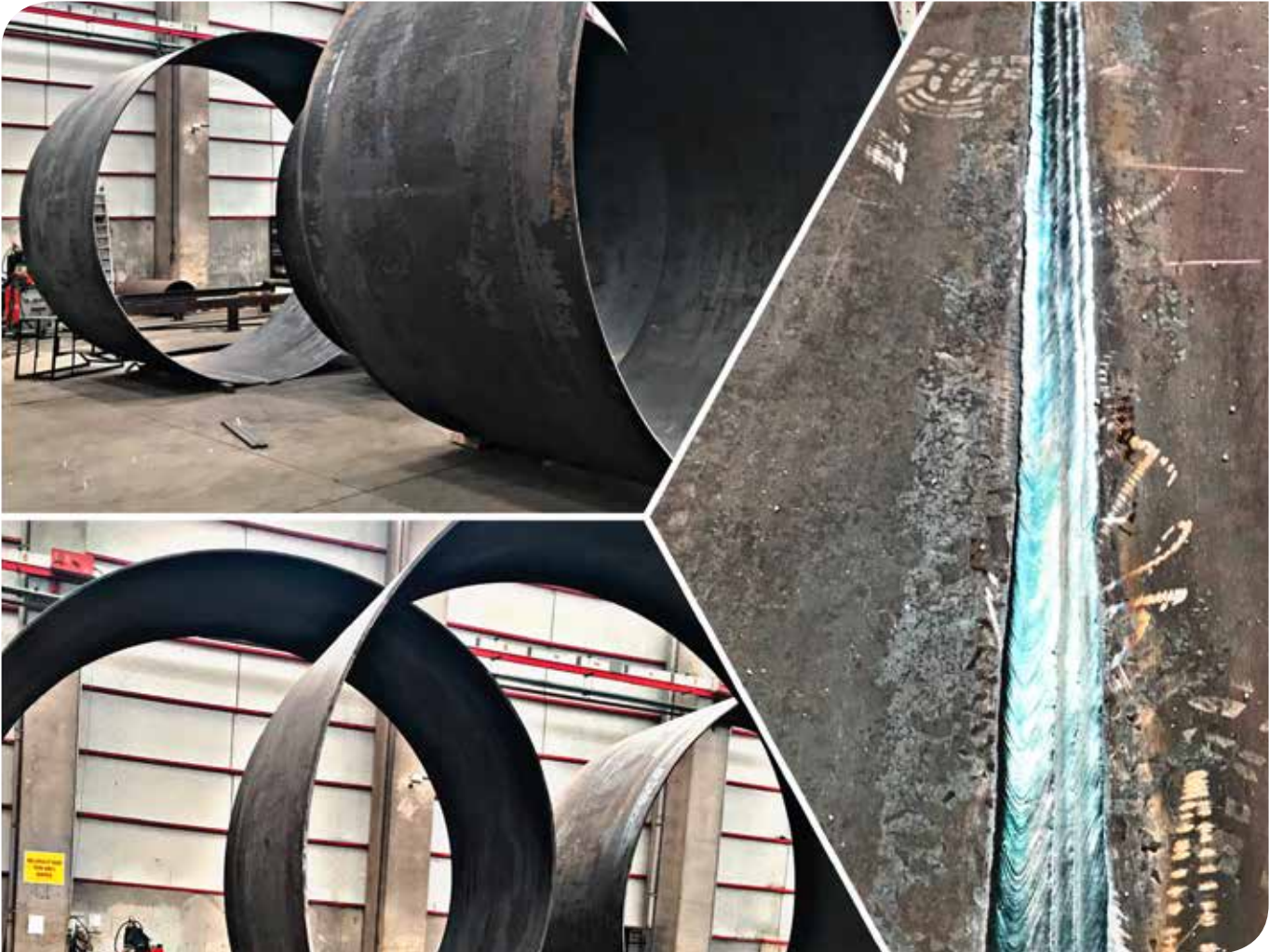

# ÇALIŞMALARIMIZDAN ÖRNEKLER

## ASAŞ ALÜMİNYUM SAN. ve TİC. A.Ş.

• Makine içi hidrolik borulama işi - Danielli projesi

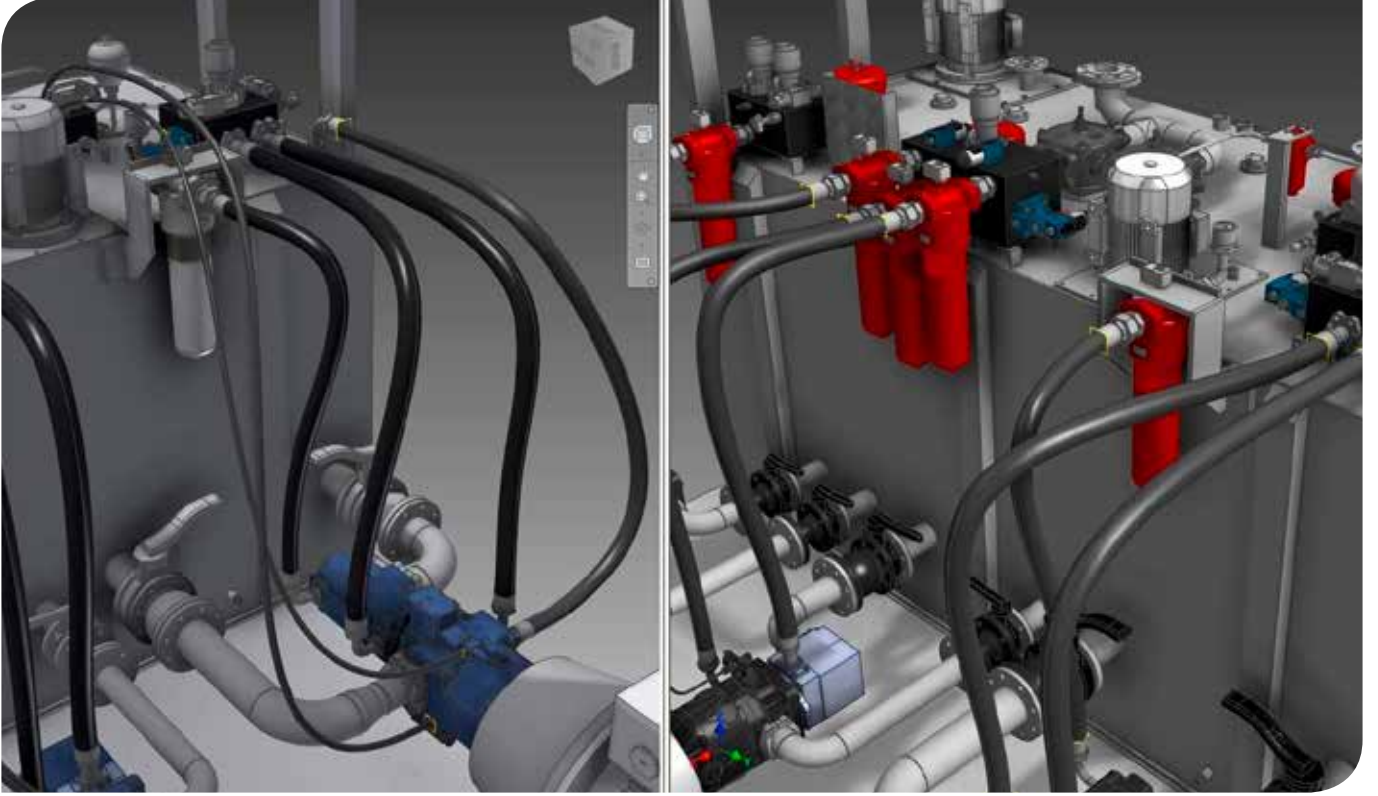



## SİSTEM TEKNİK SANAYİ FIRINLARI A.Ş.

• Isıl işlem fırını montajı (Personel temini)

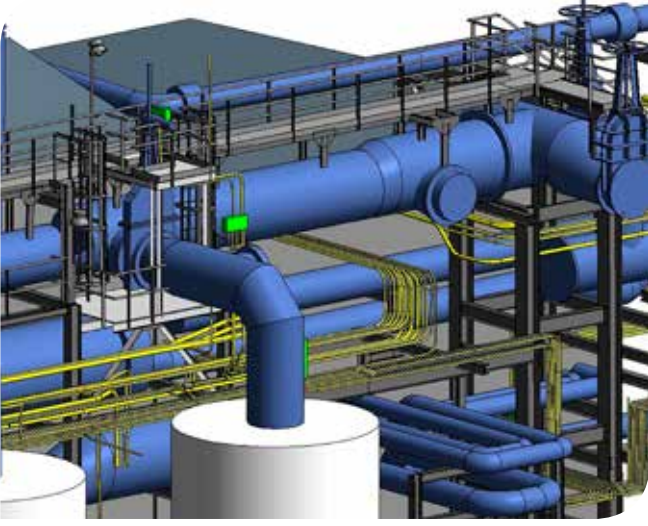

# ÇALIŞMALARIMIZDAN ÖRNEKLER

## DANIELI & C. OFFICINE MECCANICHE SpA

- Hidrolik borulama, nitelikli personel temini





## FREŞA İÇECEK SAN. TİC. A.Ş.

- Yüksek basınç hava tesisatı ve makine bağlantıları işi



# ÇEŞİTLİ İŞLERİMİZDEN ÖRNEKLER



# REFERANSLARIMIZDAN BAZILARI



Gemlik Ticaret ve Sanayi Odası



"İster büyük olsun ister küçük, Şantiyelerin aksamadan sağlam adımlarla yürütülebilmeleri için benimsemiş olduğumuz ana formül"

MANAGEMENT

METHOD

MATERIAL

MACHINE

MAN

SAFETY

QUALITY

